

Article number: 03506220

Description: Fluro Rod end GE 220FO-2RS

Measures

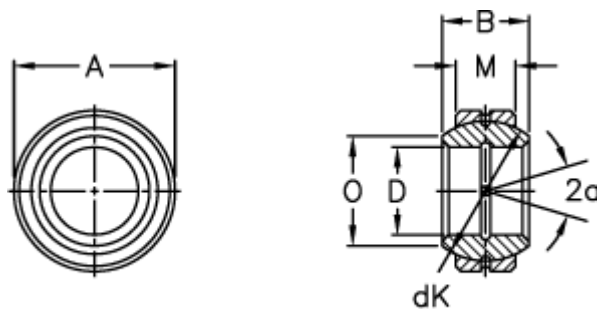

Str. 6-12 uden smørerille

A = 340 0 -0,040

B = 175

D = 220 0 -0,030

dK = 300

Dynamic load C (kN) = 2550

M = 100

O = 243.6

Static load C0 (kN) = 12700

Tilt angle = 16

Weight = 50900